

LIBERTY RACHELE 140

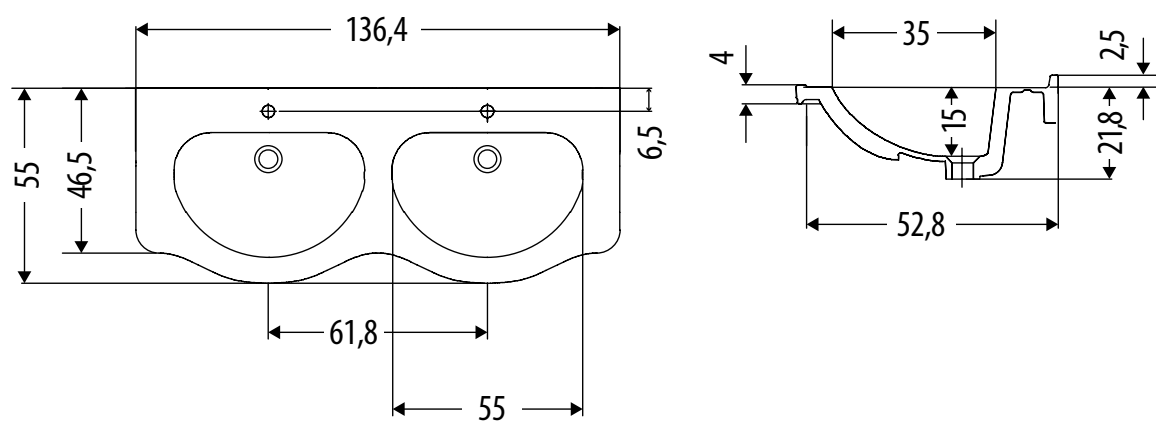

Le misure espresse sono fornite dal costruttore pertanto eventuali variazioni o modifiche non sono direttamente imputabili alla Eban s.r.l.
Measures, as indicated, are provided by the manufacturer, therefore any changes or modifications are not directly imputable to Eban s.r.l.

EBAN s.r.l.

Via Maestri Del Lavoro 28/30 - 62019 Recanati (MC) Tel +39 0717578025 - Fax +39 071987119
e-mail: info@ebansrl.it - www.ebansrl.it